



Technical Information

## Dynamic Precision – Machining Dynamically and with High Accuracy

Increased productivity and cost reduction are preeminent goals of modern manufacturing enterprises. Demands for reduced scrap, faster machining times and avoidance of additional work steps or rework are closely related to these goals. In the conflict of interests between machining time, surface quality and workpiece accuracy, machine tool controls must therefore be capable of making an approach optimized for the milling machine and the manufacturing process.

Under the concept of Dynamic Precision, HEIDENHAIN describes a group of functions for TNC controls that dramatically improve the contouring accuracy of machine tools even at high feed rates and in complex contouring moves. The dynamic accuracy of a machine tool is determined by the feed-axis acceleration required in order to produce precise movement between the workpiece and tool.

When feed axes are accelerated, machine components can be deformed by inertia forces or even begin to vibrate. With Dynamic Precision, the dynamic errors at the Tool Center Point (TCP) that arise during machining are significantly reduced so that NC programs are run with better component accuracy and surface quality, and even noticeably faster.



Through a significant reduction of error at the tool center point during the highly dynamic execution of NC programs, Dynamic Precision makes a valuable contribution to improving the performance of machine tools.

Users save time and costs for unnecessary scrap because the higher dynamic accuracy of machine tools with Dynamic Precision manifests itself in shorter machining times, improved workpiece accuracy and greater surface quality.

dynamic + precision

# Dynamic Precision

## Shorter machining times, higher accuracy, better surfaces

The defects visible on the workpiece surface and the measurable geometrical errors can be attributed to three classes of error.

The effect of errors in the real machine kinematics are described by the kinematic model in the control in the form of **kinematic** or **static errors**. In practice, the following factors have effects on the accuracy of machine kinematics.

- Production and assembly accuracy of the machine components
  - Weight-induced sag or the associated deformations of the machine frame
- On high-value machine tools, the kinematic errors usually change only slightly and can be mapped and compensated using the TNC software options KinematicsComp and KinematicsOpt.

The class of **thermally induced errors** describe the effects of temperature fluctuations in the machine frame or in the workpiece on accuracy at the tool center point (TCP). Temperature fluctuations in the frame are caused by:

- Cold or warm air streams in the machine hall
- Exposure to sunlight
- Heat generation from components and drives in a machine tool
- Cold or warm cooling lubricant movements in the machine's working space

Thermal errors of machine tools can become apparent on the workpiece in periods of from a few minutes to several hours. With the software option KinematicsOpt, users of five-axis machines can effectively compensate the effects of thermal errors on the position of rotary table in short time periods.

The **dynamic errors** of a machine tool include brief deviations or vibrations at the tool center point. Dynamic errors have the following causes:

- Feed forces and feed torque as well as machining forces cause position errors and angular errors at the tool center point.
- Following errors between the nominal position and actual position of the feed axes cannot be completely compensated by the drive control.

The dynamic errors generally increase when the speed of NC program execution increases. Therefore, efforts to reduce machining time can have negative effects on accuracy and surface quality. The flip side is that more exact contours have to be bought with longer machining times.

This applies particularly to the machining of **free-form surfaces** with the highest possible surface quality together with high accuracy. Many free-form surface operations combine corners with slightly curved surfaces. Frequent changes in milling direction are the result. Axes have to accelerate or decelerate with each directional change. The measure for the duration of changing acceleration is jerk. High jerk makes for a fast increase in acceleration and therefore saves time. However, high jerk also can excite machine vibrations and result in inaccuracy and errors on the workpiece surface. To keep the deviations from dynamic error as small as possible, traverse must be slow.

**Slightly curved** or lightly inclined surfaces often cause problems through shading on the surface. This can be the result of machine vibrations, but also come from external disturbances.

With **5-axis machining**, linear axes are subjected to highly dynamic motions (high feed rate, high acceleration) due to compensatory movements. This can result again in large deviations due to vibrations or other dynamic errors.

Because the dynamic accuracy of a machine can change with **increasing age and depending on the load**, additional deviations can occur. These effects become evident mainly in the acceleration phases.

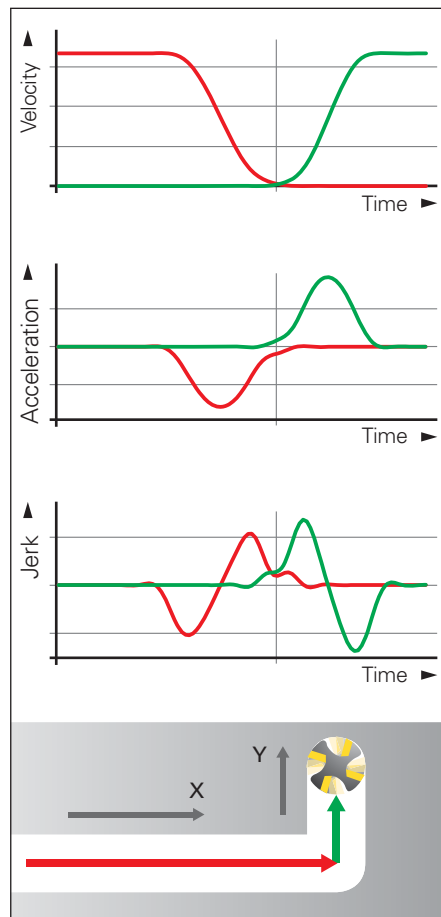

Machining a corner: velocity, acceleration and jerk in the two axes X and Y

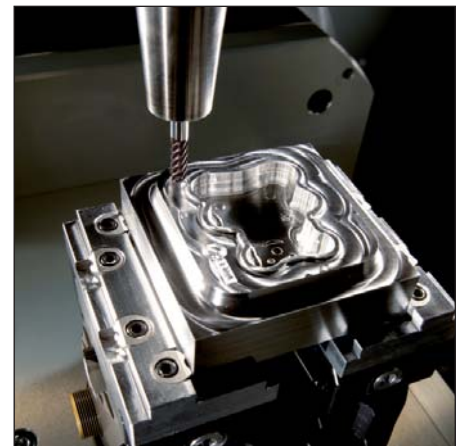

The concept of **Dynamic Precision** comprised optional functions for HEIDENHAIN controls that effectively reduce the dynamic errors of machine tools. They improve the machine's dynamic performance, attain higher stiffness at the TCP and therefore permit milling at the limit of the technologically possible depending on the machine's age, load and the machining position.

### Benefits of Dynamic Precision for the end user

It's no longer necessary to machine slowly in order to produce accurate workpieces with high surface quality. Machine tools that operate with Dynamic Precision can machine **quickly and precisely** at the same time.

High precision together with fast machining also means an increase in productivity. Unit costs are reduced without compromises in accuracy and surface quality.

Dynamic Precision also ensures that accuracy is retained regardless of operating time and weight. It isn't necessary to reduce feed rates due to age or load.

### What is Dynamic Precision?

The functions of Dynamic Precision are available as options for controls from HEIDENHAIN. They can be applied individually as well as in combination.

- CTC – Compensation of acceleration-dependent position errors at the tool center point, thereby increasing accuracy in acceleration phases
- AVD – Active vibration damping for better surfaces
- PAC – position-dependent adaptation of controller parameters
- LAC – Load-dependent adaptation of control parameters enhances accuracy regardless of load and age
- MAC – Motion-dependent adaptation of control parameters

The following is a detailed description of these functions.

### How does Dynamic Precision work?

The functions of Dynamic Precision are adapted at high clock rates in the controller unit—a component of HEIDENHAIN controls—to the movements and loads of the machine tool.

Because Dynamic Precision consists of software functions, it requires no intervention in the mechanics of the machine or in its power train. However, the machine manufacturer has to enable the individual functions, enter their parameters and adapt them to the machine.





# CTC

## Compensation of acceleration-dependent position errors at the tool center point

Dynamic acceleration processes cause forces that can briefly deform parts of the machine. This can result in deviations at the tool center point (TCP). Besides deformation in axis direction, the dynamic acceleration of an axis due to mechanical coupling can also cause deformation of axes that are perpendicular to the direction of acceleration. This applies in particular if the feed forces are not at an axis's center of gravity. The mass and inertia can therefore cause pitching movements during the braking and acceleration phases (see Figure 1).

The resulting position errors in the direction of the accelerated axis and perpendicular axes are proportional to the acceleration of the moving feed axes (Figure 2). The errors also depend on the stiffness of the guideways, the distance between the feed force application point and the center of mass as well as the distance between the center of mass and the tool center point.

These deviations are not recognized by the position encoders. The feed axis servo control therefore cannot react to them.

### Effects on the workpiece

The effect becomes most visible when the same point on a workpiece is approached first with high acceleration and then with low acceleration.

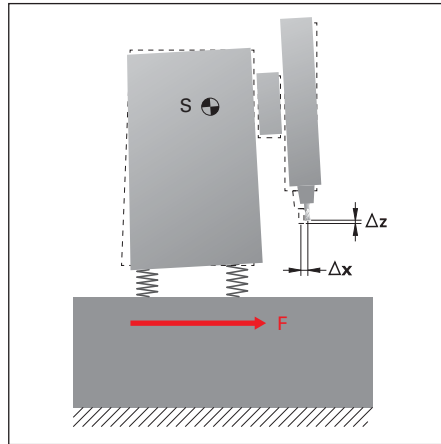

Figure 1: Pitch error in an axis

### Example 1: Milling circles

The stud (R32 F10000) is machined too large due to a dynamic elasticity in the X and Y axes. This is illustrated when the square beneath the stud is machined. Because the length of its side exactly equals the diameter of the stud, the square and the circular stud ideally form a tangent (Figure 3). However, because the stud is too large due to elasticity, a part of the stud is milled away when the square beneath it is machined. A flat area appears on the circle (Figure 4).

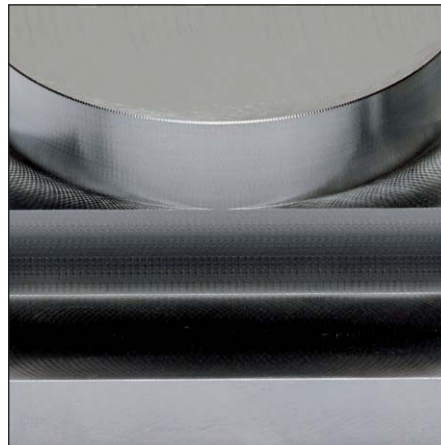

Figure 3: Stud on a square, milled with CTC. No visible flat spot.

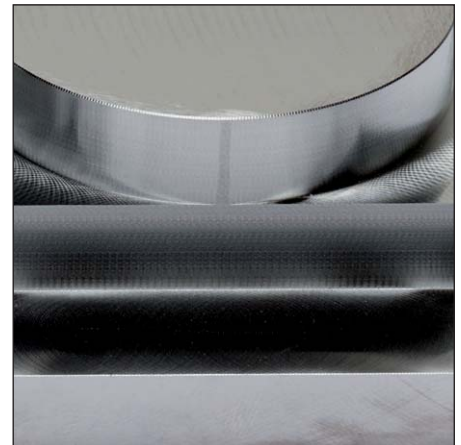

Figure 4: Effect of elastic deflection (the overlarge stud is flattened when the square is milled)

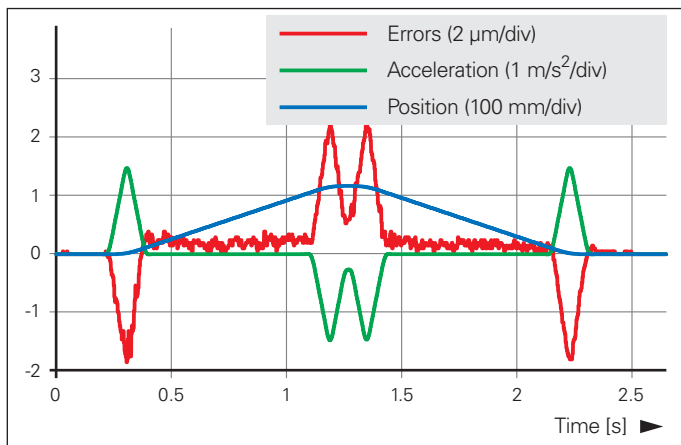

Figure 2: Error due to acceleration during position changes

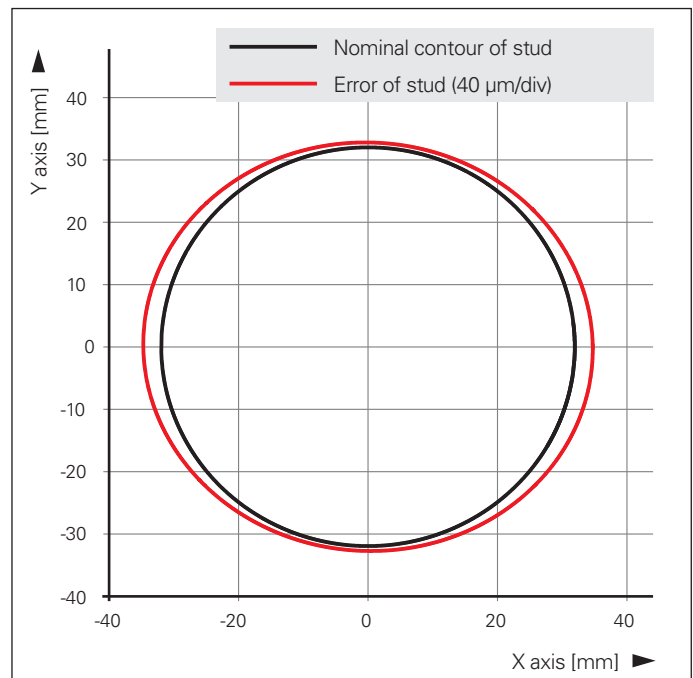

Figure 5: Accuracy of the circular movement. The deviation from the nominal contour is shown enlarged 500-fold

This effect of elasticity is illustrated in Figure 5. The acceleration-induced deviations known from measurements are added to the actual movement. Due to the various conditions in the X and Y directions (masses, machine geometry, etc.), the resulting path forms a slight ellipse.

Figure 6 shows the error without enlargement. It clearly illustrates that the elasticity causes a radius enlargement in the X direction of approx. 5 µm, which results in a 1.2 mm wide flat area on the circle when the surface beneath it is milled. This also equals the error measured on the actual workpiece.

**Example 2: Pocket milling, elasticity perpendicular to the direction of acceleration**

When pockets are milled, acceleration-induced deformations of the axes perpendicular to the direction of motion can cause surface blemishes (Figure 7). The acceleration process results in a pitching movement. The cutter is briefly pressed into the material. CTC removes this faulty movement (Figure 8).

**Compensation through CTC**

With its CTC function (Cross Talk Compensation), HEIDENHAIN offers a control option for compensation of acceleration-induced position error at the tool center point. The quantities and parameters involved are either known in the control (acceleration) or can be determined in a measuring process (machine stiffness).

It makes it possible to manufacture more accurate parts without changing the machine mechanically or increasing the machining time. In addition, the accuracy attainable with CTC does not depend on the traversed acceleration movements.

**Effects in practice**

With the aid of CTC, it proved possible to reduce mean error by up to 80 % as measured by a grid encoder. This makes it possible to increase jerk (measure for the duration of changing acceleration) and therefore also significantly reduce machining time.

An increase in jerk by the factor of 2 made it possible to reduce contouring times by up to 15 %. Thanks to CTC, the mean error was nevertheless only 50 % of that attained without CTC.

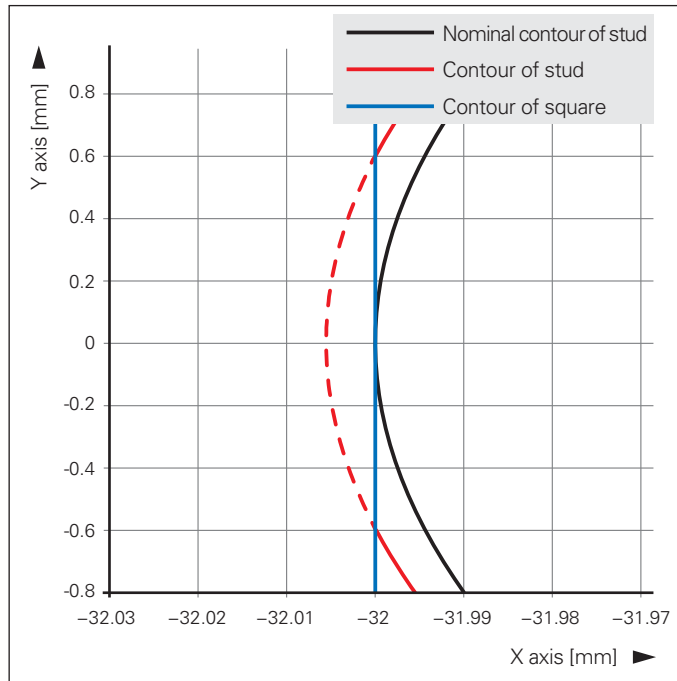

Figure 6: This detail section shows the damage to the stud from milling the square



Figure 7: Machining without CTC



Figure 8: Machining with CTC

# AVD

## Active vibration damping

Inclined or curved surfaces often have finish problems in the form of visible shadows or fluctuations in contrast. They are especially disturbing because at typical viewing distances of 30 or 60 cm the human eye is very sensitive to contrast fluctuations with a position period of 0.5 mm to 5 mm. The shadows can be attributed to fundamentally different causes:

- Mechanical vibrations resulting from elasticity in the power train or the machine setup
- Position errors within one signal period (interpolation error) due to the encoder. (See the Technical Information document *Perfect Surfaces through HEIDENHAIN Encoders*)

This Technical Information describes the surface errors caused by mechanical vibrations.

Periodic shading is usually caused under low-frequency vibration up to 100 Hz. At the usual finishing feed rates of 3000 to 6000 mm/min, such vibrations become visible exactly in the area of these position periods. Depending on the incidence of light, contour deviations as small as 1  $\mu\text{m}$  and smaller can be visible.

There are two frequent causes for surface quality problems:

- **Elasticity in the drive train**  
Elastic deformations of the ball screw or elasticity in the drive belt, for example, can cause vibration in the power train between the drive side (motor) and the friction side (slides).
- **Vibrations from machine setup**  
Vibrations from machine setup are inevitable. Machine setup vibrations are typically in the frequency range of 10 Hz to 30 Hz.

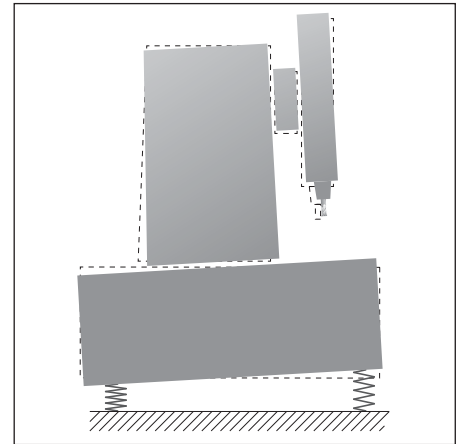
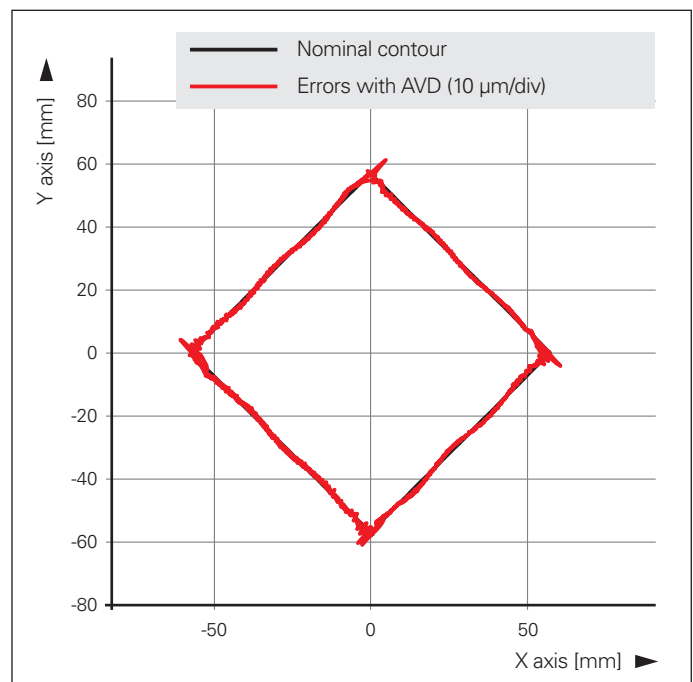
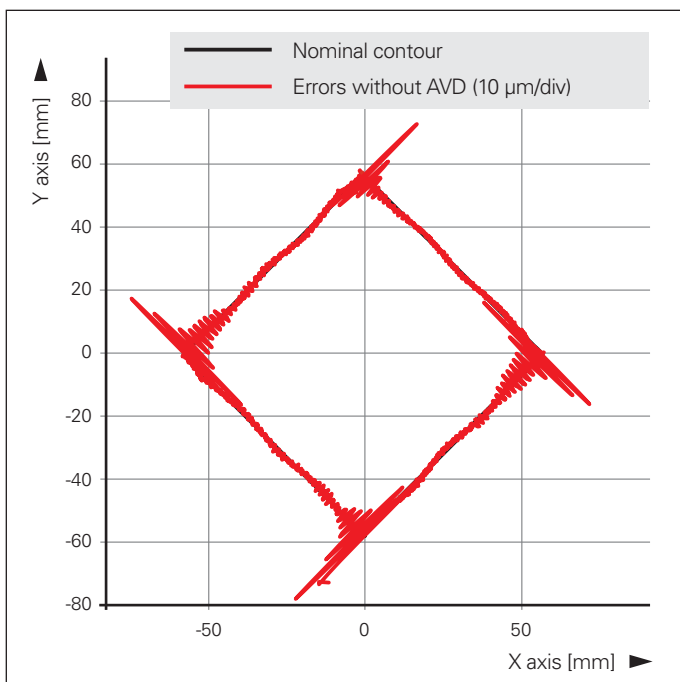

Figure 1: Vibrations from machine setup



Figures 2 and 3: Errors due to vibrations

**Conventional countermeasures**

Vibrations can be excited by acceleration processes in the machine or cross-coupling through the floor, by the cutter engagement as well as by torque ripple in the motor. While excitations through acceleration processes can be reduced by lowering the jerk, this causes longer machining times.

**Compensation through AVD**

The AVD feature (Active Vibration Damping) suppresses dominant low-frequency vibration (machine setup vibrations or elasticity in the power train).

AVD makes milling operations fast and vibration-free. By suppressing the disturbances resulting from acceleration processes, high jerk values and therefore higher acceleration can be realized. This reduces machining times without impairing the surface quality of the workpiece.

**Effects in practice**

In this example, two squares are arranged at different angles to each other. The acceleration processes at the corners excite vibrations in the X and Y axes (Figures 2 and 3). The vibration components perpendicular to the workpiece surface are visible in the shading (Figure 4). The period length of 2 mm at a feed rate of 2000 mm/min results from the measured setup vibration of 16.5 Hz. With AVD, it was possible to nearly eliminate the vibration amplitude (Figure 5).

To attain comparable surfaces without AVD it would be necessary to reduce the jerk values by a factor of 3.

**Conclusion**

AVD increases the productivity of a machine tool and/or improves the surface quality of the workpieces.

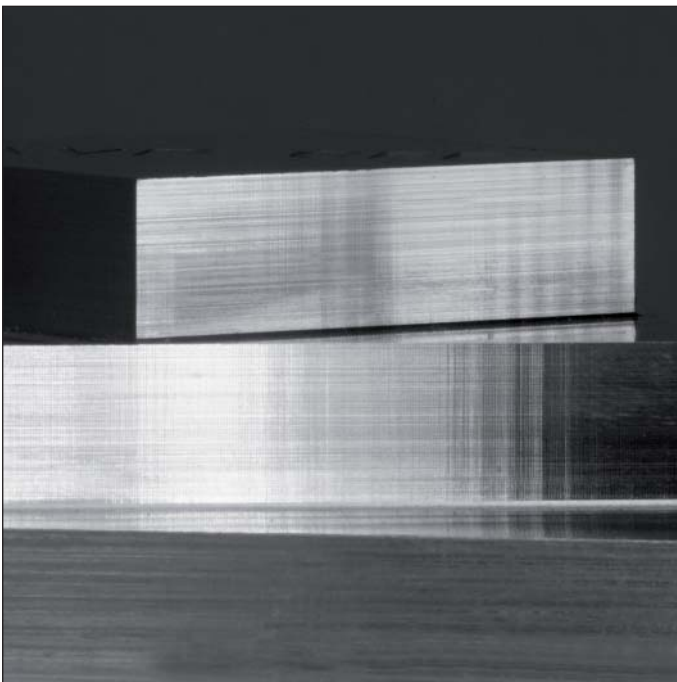

Figure 4: Vibrations can significantly impair surface quality.

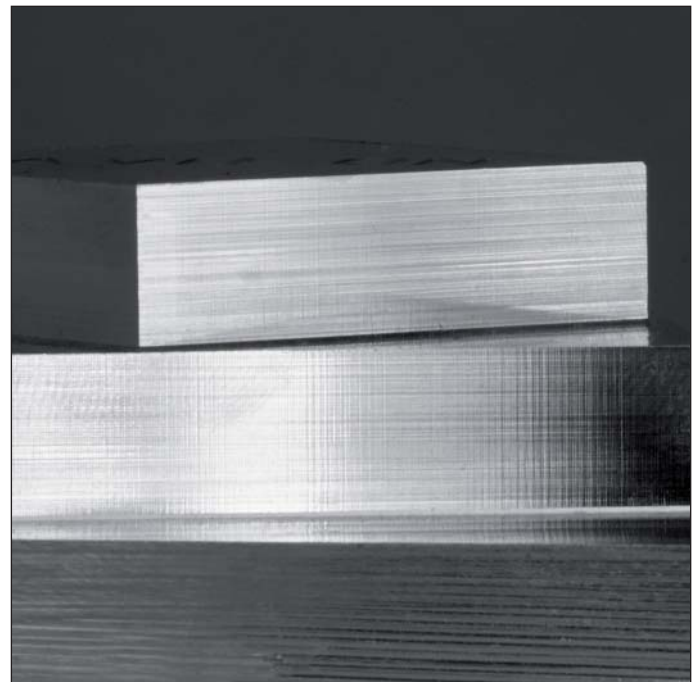

Figure 5: With AVD, visibly superior surface quality is achieved

# PAC

## Position-dependent adaptation of control parameters

Depending on the positions of the axes in a working space, the kinematic conditions of a machine give it a variable dynamic response that can adversely affect the stability or quality of the servo-control.

Changes in axis positions also change the mass ratios in a machine (see Figure 1). Stiffness values can also change depending on position, as for example on ball-screw drives. The changed mass ratios and stiffness values cause a shift of natural frequencies in the drive train. This results in a varying control behavior depending on position.

The following error can serve as a measure of control quality. It is an indicator of how well the control traces a nominal contour.

### Conventional measures

The control loops of the axes must always be adjusted so that they can stay stable and robust at any possible position. It is therefore always necessary to adjust for the weakest position. These positions are frequently located at the edge of the traverse range (limit of the working space, tool changer, loading position of the table, etc.). In the center of the working space, where most of the most precise machining is required, the controller dynamics and the dynamic accuracy resulting from it could be significantly increased.

Adjustment to the weakest position leaves unused potential for improving the dynamic accuracy.

### Benefits of PAC

The PAC option (Position Adaptive Control) from HEIDENHAIN can change machine parameters depending on the axis positions and in this way better exploit the machine's dynamic capabilities.

Control can be optimally adapted to the machine through position-dependent filter settings and control factors in order to achieve the best results at any position within the working space. In addition, it can increase dynamic accuracy at the positions that are relevant for the largest share of machining.

The higher the control factors are set, the better the suppression of interference (e.g. gear transmission error, torque ripple in the motor) and the smaller the following error becomes. And this, in turn, results in better contour accuracy.

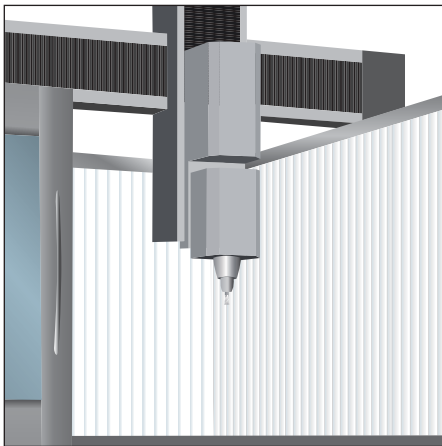

Servo control optimized for Z = 0, following error within the tolerance band ( $\pm 1 \mu\text{m}$ )

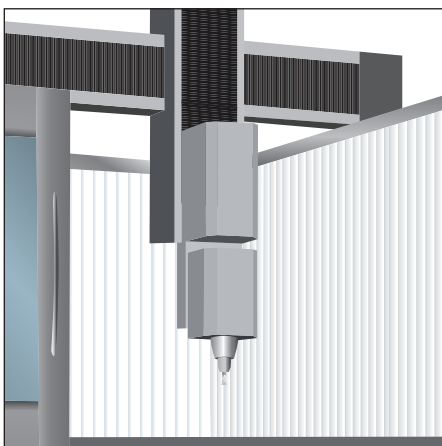
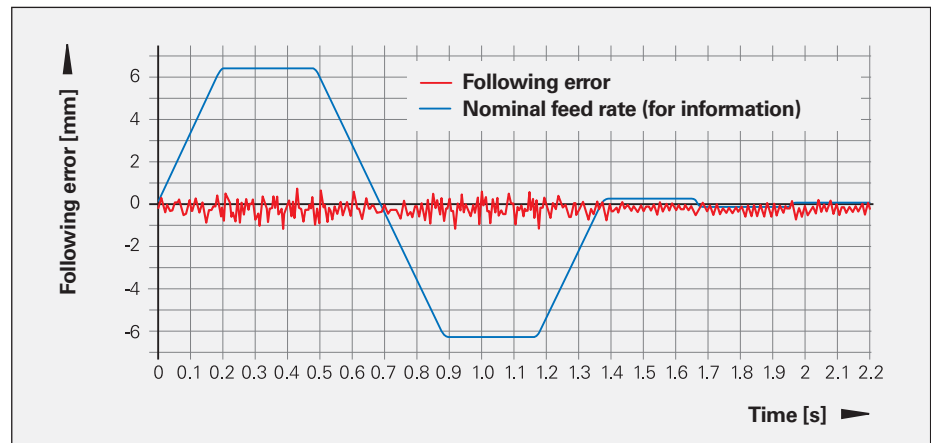

Servo control at Z = -500

- Without PAC: Clearly visible oscillations and following error outside of the tolerance band ( $\pm 3 \mu\text{m}$ )
- With active PAC: Following error stays within the tolerance band ( $\pm 1 \mu\text{m}$ )

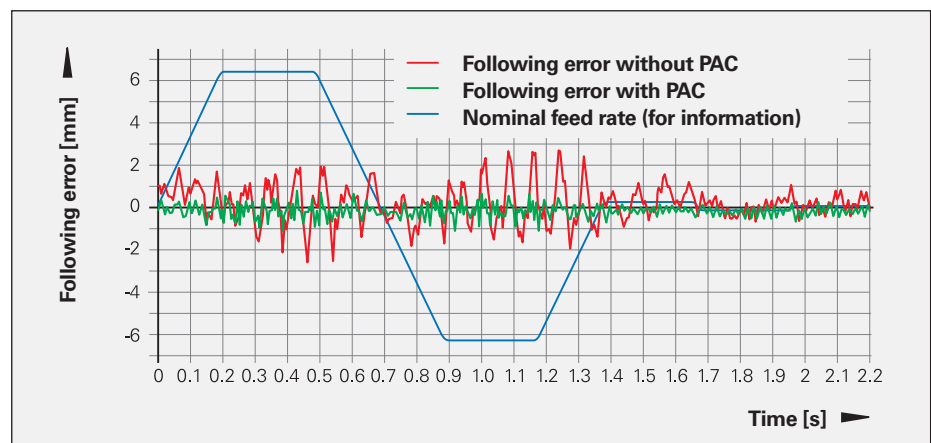



# LAC

## Load-dependent adaptation of control parameters

The dynamic response of machines with moving tables can vary depending on the mass (linear axis) or mass moment of inertia (rotary axis) of the fixed workpiece. The values for the friction and acceleration feedforward control of an axis apply only for the mass or the mass moment of inertia that existed during the adjustment process. Under other load conditions, the feedforward values no longer apply to the actual situation. This expresses itself as an enlarged following error during the acceleration phases, which can then result in contour deviations.

### Conventional measures

Machine tool builders can prepare parameter sets for various load situations that can be activated through a cycle call. This does reduce the following error, but residual errors always remain depending on the load conditions.

A typical example is two parameter sets for the load conditions 0 kg to 150 kg (adjusted for 75 kg) and 150 kg to 500 kg

(adjusted for 325 kg). In the worst case, the actual mass differs from the adjusted load situation by up to 175 kg.

The situation becomes more critical with a rotary table. Here the inertia, not the mass, is relevant for the feedforward parameter values. Suboptimal workpiece setup can easily multiply the mass moment of inertia from the same mass.

### Compensation through LAC

The LAC option (Load Adaptive Control) from HEIDENHAIN enables the control to automatically ascertain the current mass with linear axes and the mass moment of inertia with rotary axes as well as the friction forces. In order to optimize changed control behavior at differing loads, adaptive feedforward controls can exploit data on acceleration, holding torque, static friction and friction at high shaft speeds. During workpiece machining, the control can also continuously adjust the parameters of the adaptive feedforward control to the current mass or mass moment of inertia of the

workpiece. The adaptation velocity is preset by parameter. Because the machine operator cannot enter the load situation on his own, this rules out operator error.

### Further benefits of LAC

The aging of machine components, such as guideways or ball screws, can greatly change frictional forces over the service life of a machine tool. An optimal feedforward adjustment for a machine in shipping condition no longer applies after a few years. The LAC option ensures that the axis is always optimally adjusted.

However, quickly changing friction conditions that result, for example, from lubrication pulses on sliding guides, can also be optimally compensated by LAC.

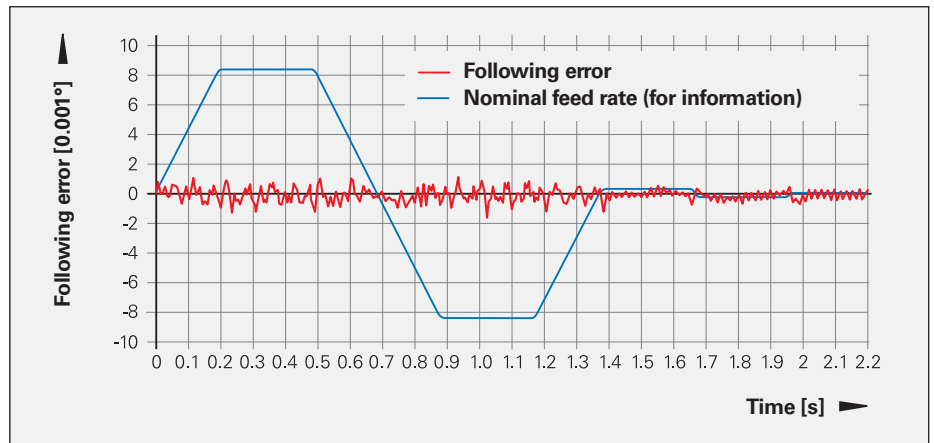
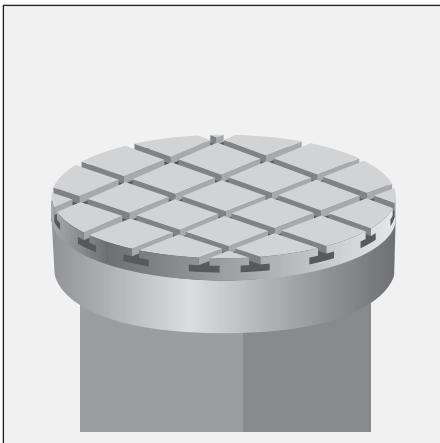

Optimal feedforward control for rotary tables without additional load and with following error within the tolerance band ( $\pm 0.001^\circ$ )

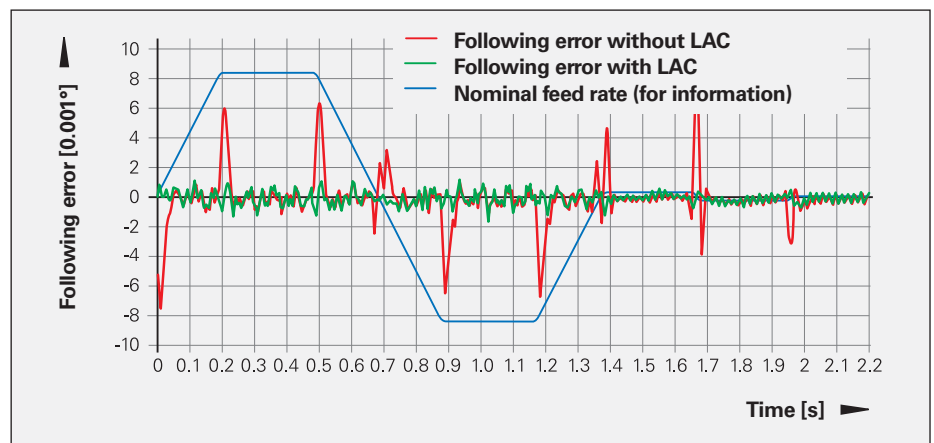
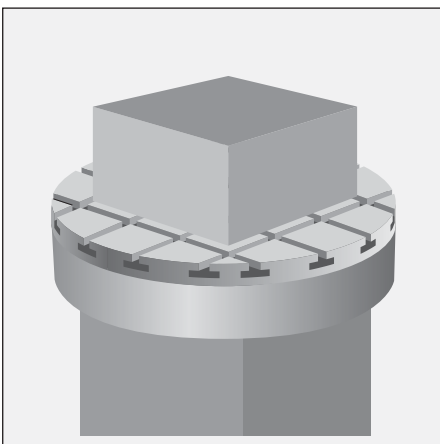

Additional load changed

- Without LAC: When the feedforward control is unchanged, the following error is outside of the tolerance band ( $\pm 0.008^\circ$ )
- With LAC: When LAC is active in the feedforward control, the following error is within the tolerance band ( $\pm 0.001^\circ$ )

# MAC

## Motion-dependent adaptation of control parameters

Machine behavior changes depend not only on the position of the axes in the working space, but also on their velocity. Among other things, this can also be attributed to the influence of velocity on friction in the guideways. Changed frictional conditions can affect the vibration behavior of a machine tool. Optimal controller settings that are typically conducted for standstill, can lead to strong vibrations at rapid traverse.

In addition, MAC makes it possible to easily change the bearing preload of a rack-and-pinion drive with two independent feed motors depending on the velocity.

### Benefits of MAC

#### Example 1

The MAC option (Motion Adaptive Control) makes it possible to change machine parameters depending on other input quantities such as velocity, following error or the acceleration of a drive. Through this motion-dependent adaptation of the control parameters it is possible, for example, to realize a velocity-dependent adaptation of the control loop gain on motors whose stability changes through the various traversing velocities. In this way, the optimal controller settings can be applied for any machining situation. This provides optimal interference suppression and improves the dynamic performance of the machine.

#### Example 2

A further application is the acceleration-dependent change of the tensioning torque between master and slave for master-slave torque control. With the MAC option, this arrangement makes it possible to attain a significantly higher maximum acceleration at rapid traverse, for example through parameterized reduction of the tensioning torque with increasing acceleration.

In addition, a reduction of the tensioning torque at standstill significantly decreases heat conduction into the machine, which also reduces thermally induced deformation or drift.

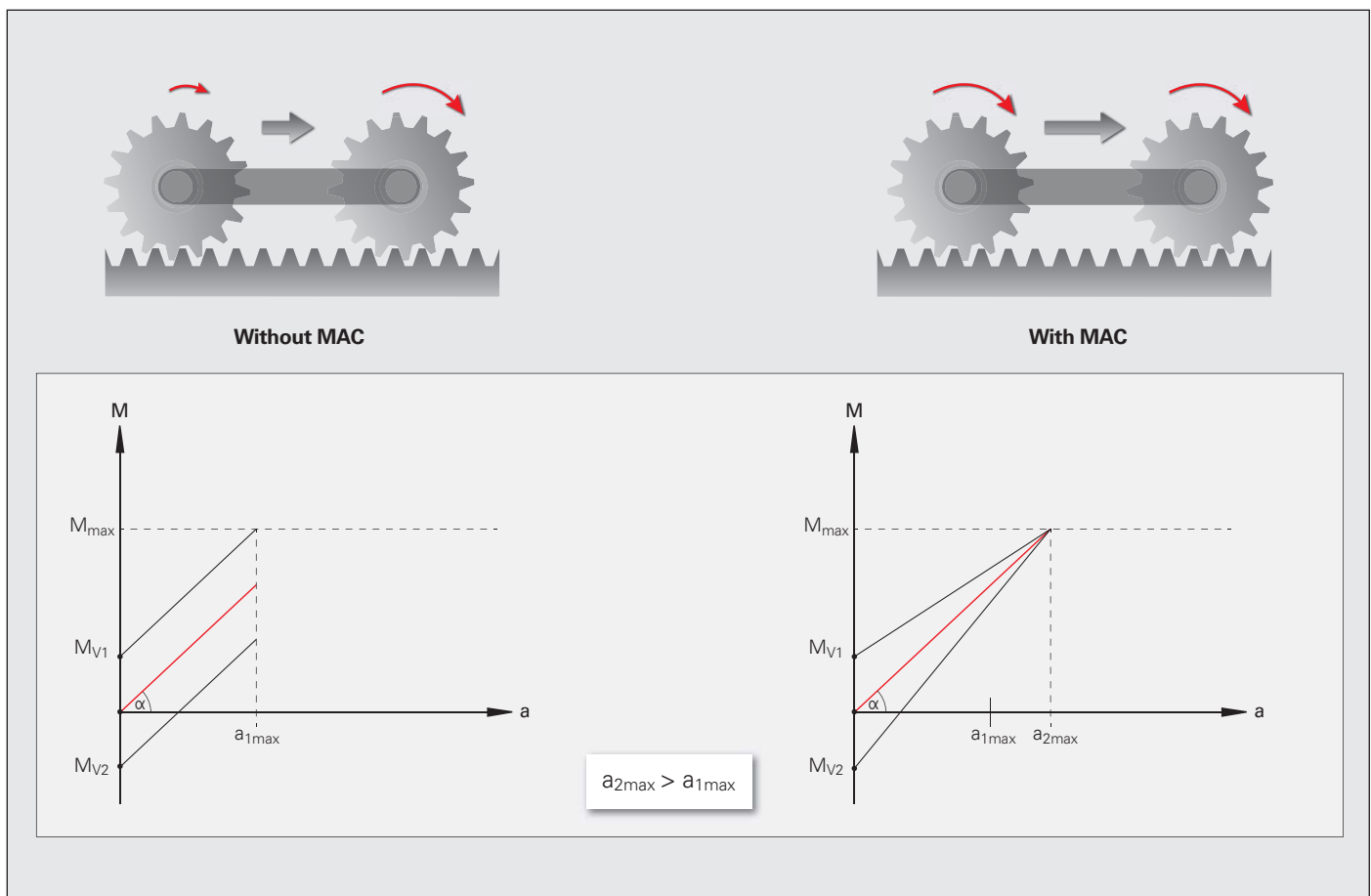

# Dynamic Precision

Functions are perfectly matched



The functions comprised by Dynamic Precision complement each other perfectly. A simple example contour—shown black in the respective graphs—illustrates this for CTC and AVD. The errors at the TCP were recorded with a grid encoder at a feed rate of 10 000 m/s. The deviations from the contour are shown in the graphic enlarged 500 times.

Figure 1 shows the deviations from the nominal contour as a red line. Particularly in the acceleration phases at the corners, the error values are quite high due to the high velocity.

With Dynamic Precision, here by switching on the CTC and AVD options, these errors are compensated (green line in Figure 1). The part is machined at the same feed rate with a much more accurate contour. Thanks to the reduction in error, the jerk can be increased in order to elicit more dynamic performance from the machine.

High jerks more strongly excite the machine. The resulting vibrations can become visible as shadows on the workpiece. These strong vibrations are then reduced by the AVD option.

Figure 2 compares the initial condition (red line: without Dynamic Precision at 100 % jerk) with machining with Dynamic Precision at 200 % jerk (Figure 2, green line). This clearly illustrates that Dynamic Precision, even with high dynamics, improves error by a factor of 2. Doubling the jerk made it possible to reduce the traverse time at this contour by 12 %.

	Mean error	Time
CTC off AVD off R100%	2.6 µm	1.04 s
CTC on AVD on R100%	0.4 µm	1.04 s
CTC on AVD on R200%	0.6 µm	0.91 s

## Conclusion

With Dynamic Precision your work becomes significantly more accurate or—if jerk is increased—both faster and more accurate.

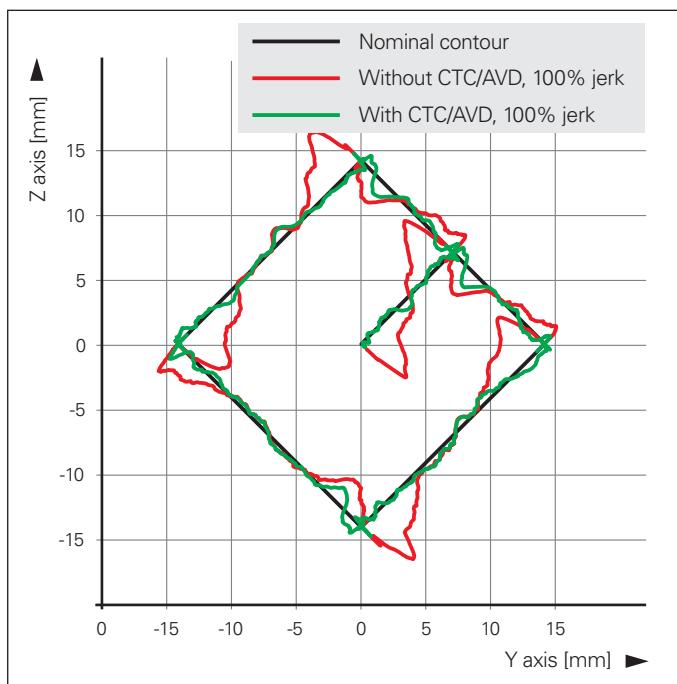

Figure 1: Errors with and without Dynamic Precision at 100 % jerk

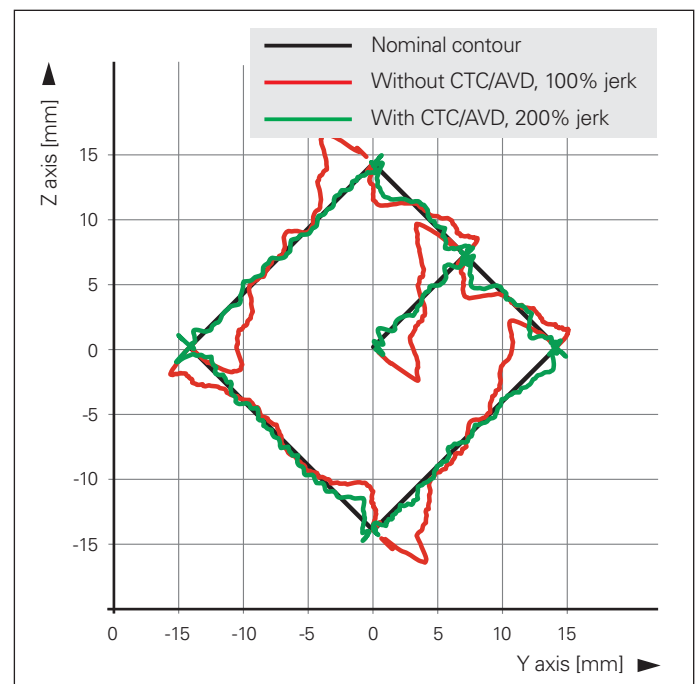

Figure 1: Errors with and without Dynamic Precision at 100 % jerk and with Dynamic Precision at 200 % jerk

# HEIDENHAIN controls

## Contouring controls for milling, milling/turning, drilling, boring machines and machining centers

The TNC controls from HEIDENHAIN cover the whole range of applications: From the simple, compact TNC 128 three-axis straight cut control to the TNC 530 (up to 18 axes plus spindle)—there's a TNC control for nearly every application. The TNC 640 is a control for milling machines that are also capable of turning operations.

HEIDENHAIN TNC controls are versatile: They are workshop oriented and feature both shop-floor and offline programming, and are therefore ideal for automated production. They handle simple milling tasks just as reliably as the TNC 640 and iTNC 530, for example, can handle high speed cutting—with especially jerk-reduced path control—or 5-axis machining with swivel head and rotary table.

HEIDENHAIN combines innovative control functions for efficient high-precision machining under the hypernyms **Dynamic Efficiency** and **Dynamic Precision**.

**Dynamic Efficiency** helps the user to make heavy machining and roughing more efficient while also enhancing its process reliability. **Dynamic Efficiency** is available on the TNC 640 and iTNC 530 controls.

**Dynamic Precision** makes workpieces more exact, with clean surfaces and high-speed machining, thereby providing high precision and higher productivity. You can use the **Dynamic Precision** software options with the TNC 640, iTNC 530 and TNC 620.



TNC 640



iTNC 530



TNC 620

	TNC 640	iTNC 530	TNC 620
<b>Dynamic Precision</b>	x	x	x
<b>CTC</b> – Compensation of position errors through axis coupling	Option	Option	Option
<b>AVD</b> – Active vibration damping	Option	Option	Option
<b>PAC</b> – Position-dependent adaptation of controller parameters	Option	Option	Option
<b>LAC</b> – Load-dependent adaptation of control parameters	Option	Option	Option
<b>MAC</b> – Motion-dependent adaptation of control parameters	Option	Option	Option
<b>Dynamic Efficiency</b>	x	x	–
<b>ACC</b> – Active suppression of chatter	Option	Option	Option
<b>AFC</b> – Adaptive feed control	Option	Option	–
<b>Trochoidal milling</b>	•	•	•

- x Functions possible
- Standard function

## HEIDENHAIN

**DR. JOHANNES HEIDENHAIN GmbH**  
Dr.-Johannes-Heidenhain-Straße 5  
83301 Traunreut, Germany

☎ +49 8669 31-0

FAX +49 8669 32-5061

E-mail: info@heidenhain.de

[www.heidenhain.de](http://www.heidenhain.de)

### For more information:

- Catalog: *TNC 640*
- Catalog: *iTNC 530*
- Catalog: *TNC 620*
- Technical Information: *Dynamic Efficiency*

